

06 NOT USED  
1 1/2" x 1'-0"

05 NOT USED  
3" x 1'-0"

04 HEAD-ATTIC VENT V-4  
1 1/2" x 1'-0"

03 NOT USED

02 NOT USED

01 HEAD DOOR 201  
3" x 1'-0"

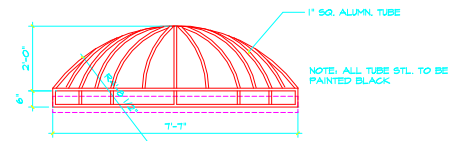
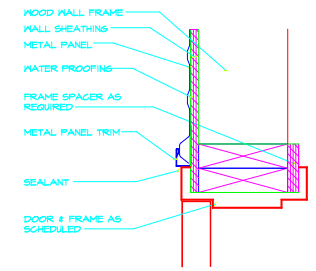
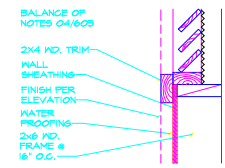
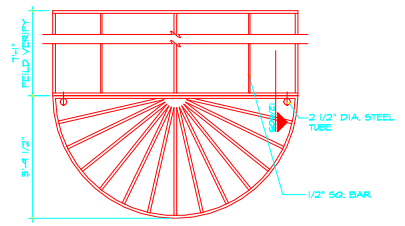

10 SILL-ATTIC VENT V-4  
1 1/2" x 1'-0"

09 NOT USED

08 NOT USED

07 JAMB DOOR 201  
3" x 1'-0"

11 ENTRY AWNING (NIC)  
1/2" x 1'-0"

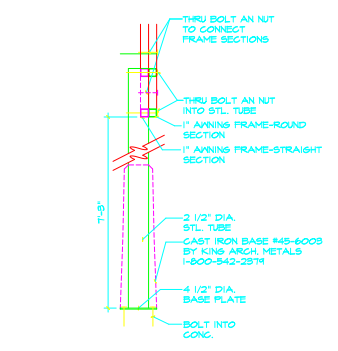
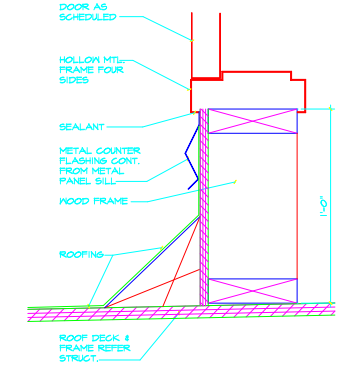
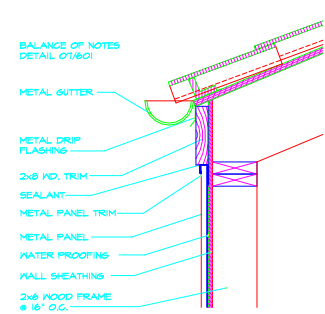
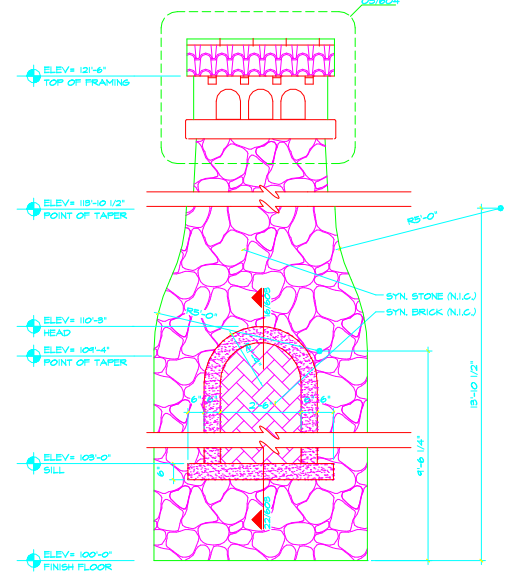

NOTE: TILE SIGN BACKGROUND BY G.C. ALL TILE TO BE BROKEN AND ASSEMBLED ON SITE

16 BROKEN TILE SIGN BACKGROUND  
1/2" x 1'-0"

15 FIRE PLACE ELEVATION  
1/2" x 1'-0"

14 EAVE AT METAL PANEL  
1 1/2" x 1'-0"

13 SILL DOOR 201  
3" x 1'-0"

12 AWNING CONNECTION (NIC)  
1 1/2" x 1'-0"

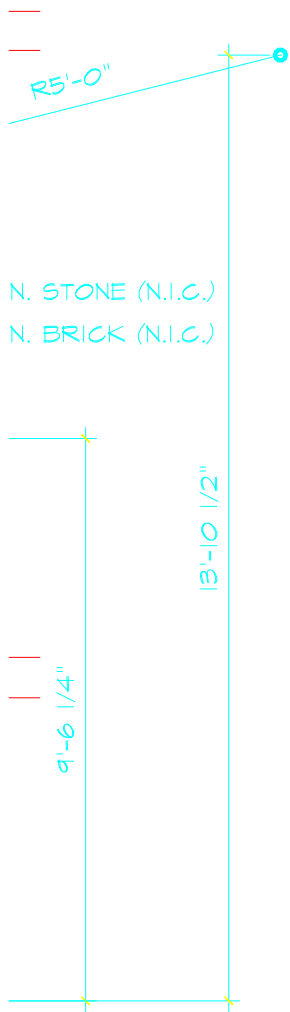

N. STONE (N.I.C.)  
 N. BRICK (N.I.C.)

BALANCE OF NOTES  
 DETAIL 07/601

METAL GUTTER

METAL DRIP  
 FLASHING

2x8 WD. TRIM

SEALANT

METAL PANEL TRIM

METAL PANEL

WATER PROOFING

WALL SHEATHING

2x6 WOOD FRAME  
 @ 16" O.C.

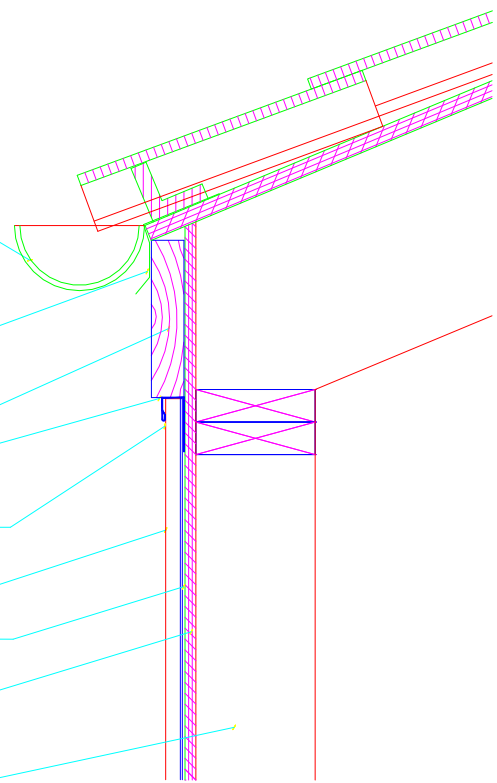

14 EAVE AT METAL PANEL 1

1 1/2"=1'-0"

AREA OF BUILDING:

JOB NO.

DATE:

C.D. REF:

C.L. REF:

0103

PROJECT:

SCALE:

SHEET:

CARINO'S PROTO

8.0 - UPDATE