

NOTE: COORDINATE INSTALLATION OF DOOR 122A FRAME WITH DELIVERY AND INSTALLATION OF ELECTRIC PANEL BECAUSE OF REQ'D OPENING SIZE FOR PANEL TO ENTER BUILDING.

**05 HEAD DOOR 114, 118, 119, 123**  
3'1"-0"

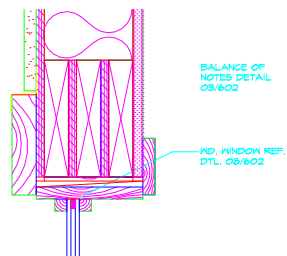

**04 HEAD WINDOW 'F'**  
3'1"-0"

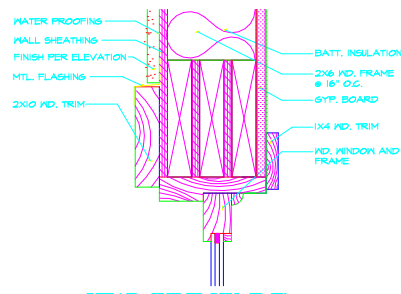

**03 HEAD WINDOW 'D,E'**  
3'1"-0"

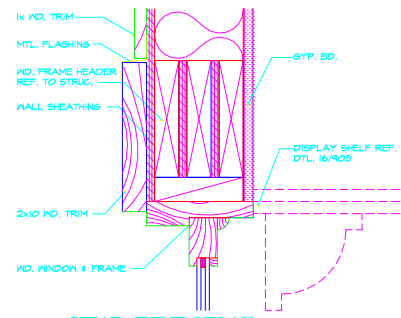

**02 HEAD WINDOW 'C'**  
3'1"-0"

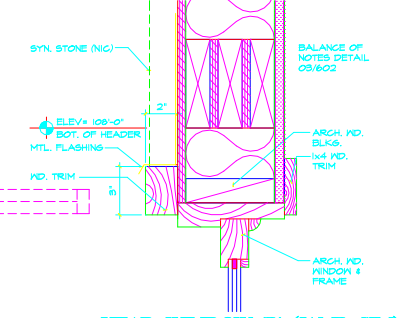

**01 HEAD WINDOW 'B' (JAMB SIM)**  
3'1"-0"

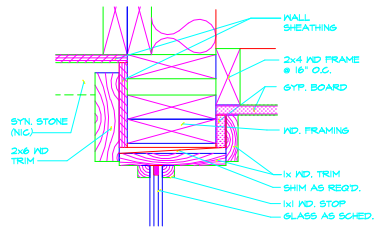

**08 JAMB WINDOW 'F'**  
3'1"-0"

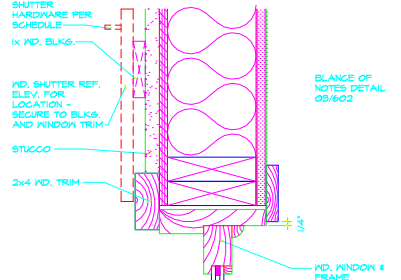

**07 JAMB WINDOW 'D,E'**  
3'1"-0"

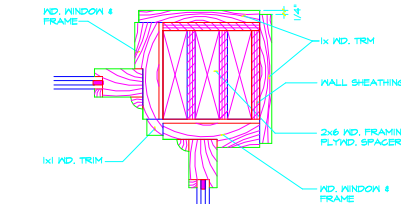

**11 JAMB WINDOW 'C'**  
3'1"-0"

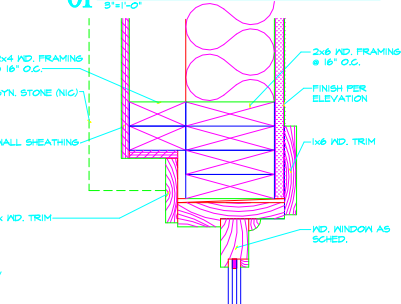

**06 JAMB WINDOW A-1**  
3'1"-0"

**09 NOT USED**

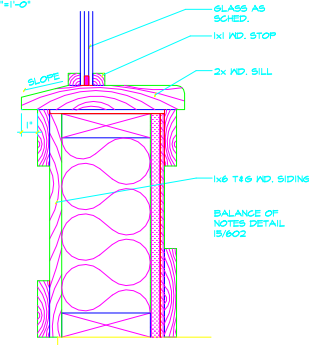

**13 SILL WINDOW 'F'**  
3'1"-0"

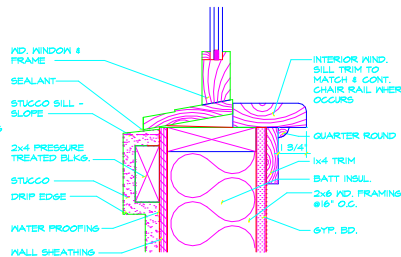

**12 SILL WINDOW 'D,E'**  
3'1"-0"

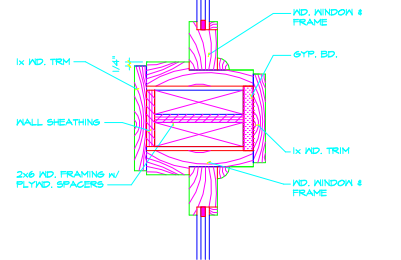

**16 SILL WINDOW 'B, C'**  
3'1"-0"

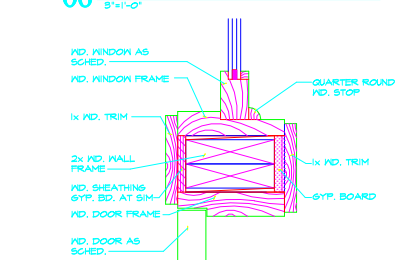

**10 JAMB DOOR 101, WIN A-1**  
3'1"-0"

**14 NOT USED**

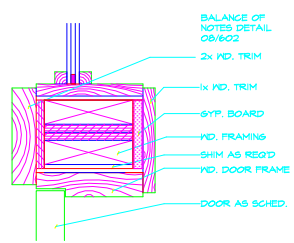

**18 DOOR JAMB 108A / WINDOW 'F'**  
1/4'1"-0"

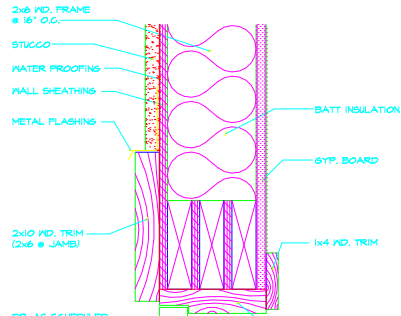

**17 DOOR HEAD 108A (JAMB SIM)**  
3'1"-0"

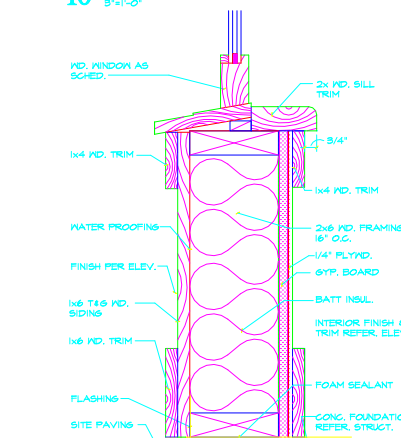
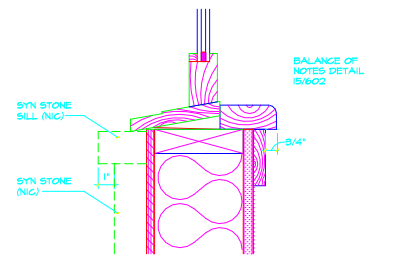

**15 SILL WINDOW 'A-1'**  
3'1"-0"

**19 NOT USED**